

PolyZen Devices

Polymer Protected Zener Diode

PolyZen devices are polymer-enhanced, precision Zener diode micro-assemblies. They offer resettable protection against multi-Watt fault events without the need for multi-Watt heat sinks.

The Zener diode used for voltage clamping a PolyZen micro-assembly was selected due to its relatively flat voltage vs. current response. This helps improve output voltage clamping, even when input voltage is high and diode currents are large.

An advanced feature of the PolyZen micro-assembly is that the Zener diode is thermally coupled to a resistively non-linear, PPTC (polymer positive temperature coefficient) layer. This PPTC layer is fully integrated into the device and is electrically in series between V_{IN} and the diode clamped V_{OUT} .

This advanced PPTC layer responds to either extended diode heating or overcurrent events by transitioning from a low to high resistance state, also known as “tripping.” A tripped PPTC will limit current and generate voltage drop. It helps to protect both the Zener diode and the follow-on electronics and effectively increases the diode’s power handling capability.

The polymer-enhanced Zener diode helps protect sensitive portable electronics from damage caused by inductive voltage spikes, voltage transients, incorrect power supplies and reverse bias. These devices are particularly suitable for portable electronics and other low-power DC devices.



Benefits

- Stable Zener diode helps shield downstream electronics from overvoltage and reverse bias
- Trip events shut out overvoltage and reverse bias sources
- Analog nature of trip events helps minimize damage from upstream inductive spikes
- Minimal power dissipation requirements
- Single component placement

Features

- Overvoltage transient suppression
- Stable V_Z vs. fault current
- Time delayed, overvoltage trip
- Time delayed, reverse bias trip
- Multi-Watt power handling capability
- Integrated device construction
- RoHS compliant

Applications

- DC power port protection in portable electronics
- DC power port protection for systems using barrel jacks for power input
- Internal overvoltage and transient suppression
- DC output voltage regulation
- Tablet PCs and portable electronics

Figure PZ1 Typical Application Block Diagram for PolyZen Devices

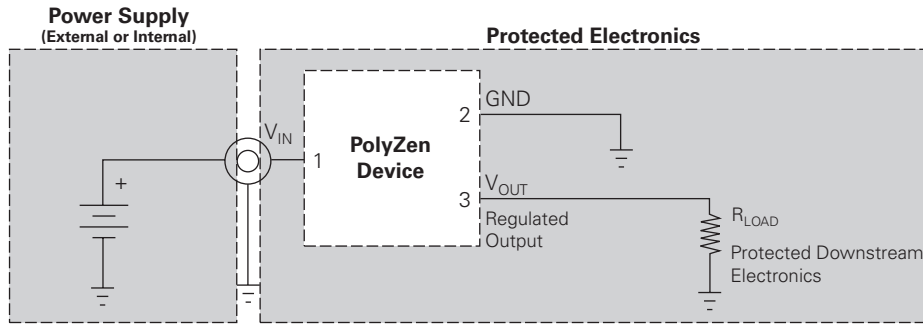

Table PZ1 Electrical Characteristics for PolyZen Devices

(Performance ratings @ 25°C unless otherwise specified)

Part Number	V _Z (V)			I _{ZT} (A)	I _{HOLD} @ 20°C (A)	R _{Typ} (Ω)	R _{1MAX} (Ω)	V _{INT MAX}		I _{FLT MAX}	
	Min	Typ	Max					V _{INT MAX} (V)	Test Current (A)	I _{FLT MAX} (A)	Test Voltage (V)
ZEN056V130A24LS	5.45	5.60	5.75	0.10	1.30	0.12	0.16	24V	3A	+10/-40	+24/-16V
ZEN059V130A24LS†	5.80	5.90	6.00	0.10	1.30	0.12	0.15	24V	3A	+6/-40	+24/-16V
ZEN065V130A24LS	6.35	6.50	6.65	0.10	1.30	0.12	0.16	24V	3A	+6/-40	+24/-16V
ZEN098V130A24LS	9.60	9.80	10.00	0.10	1.30	0.12	0.16	24V	3A	+3.5/-40	+24/-16V
ZEN132V130A24LS	13.20	13.40	13.60	0.10	1.30	0.12	0.16	24V	3A	+2/-40	+24/-16V
ZEN164V130A24LS	16.10	16.40	16.60	0.10	1.30	0.12	0.16	24V	3A	+1.25/-40	+24/-16V
ZEN056V230A16LS	5.45	5.60	5.75	0.10	2.30	0.04	0.06	16V	5A	+5/-40	+16/-12V
ZEN065V230A16LS	6.35	6.50	6.65	0.10	2.30	0.04	0.06	16V	5A	+3.5/-40	+16/-12V
ZEN098V230A16LS	9.60	9.80	10.00	0.10	2.30	0.04	0.06	16V	5A	+3.5/-40	+16/-12V
ZEN132V230A16LS	13.20	13.40	13.60	0.10	2.30	0.04	0.06	16V	5A	+2/-40	+20/-12V
ZEN056V075A48LS	5.45	5.60	5.75	0.10	0.75	0.28	0.45	48V	3A	+10/-40	+48/-16V
ZEN132V075A48LS	13.20	13.40	13.60	0.10	0.75	0.28	0.45	48V	3A	+2/-40	+48/-16V
ZEN056V115A24LS	5.45	5.60	5.75	0.10	1.15	0.15	0.18	24V	3A	+10/-40	+24/-16V
ZEN056V130A24CE	5.45	5.60	5.75	0.10	1.30	0.070	0.105	24V	3A	+10/-40	+24/-16V
ZEN056V230A16CE	5.45	5.60	5.75	0.10	2.30	0.032	0.060	16V	5A	+5/-40	+16/-12V
ZEN056V260A16CE	5.45	5.60	5.75	0.10	2.60	0.032	0.045	16V	5A	+5/-40	+16/-12V
ZEN132V130A24CE	13.20	13.40	13.65	0.10	1.30	0.070	0.105	24V	3A	+3/-40	+24/-16V
ZEN132V230A16CE	13.20	13.40	13.65	0.10	2.30	0.032	0.060	16V	5A	+3/-40	+16/-12V
ZEN132V260A16CE	13.20	13.40	13.65	0.10	2.60	0.032	0.045	16V	5A	+3/-40	+16/-12V

LS module height is 1.7mm typical. CE module height is 1.0mm typical.

† Typical operating current is 500µA @ 5.0V which meets USB suspend mode requirement.

Table PZ2 Definitions of Terms for PolyZen Devices

V _Z	Zener clamping voltage measured at current I _{ZT} and 20°C.
I _{ZT}	Test current at which V _Z is measured.
I _{HOLD}	Maximum steady state current I _{PTC} that will not generate a trip event at the specified temperature. Ratings assume I _{FLT} = 0A.
R _{Typ}	Typical resistance between V _{IN} and V _{OUT} pins when the device is at room temperature.
R _{1MAX}	The maximum resistance between V _{IN} and V _{OUT} pins, at room temperature, one hour after first trip or after reflow soldering.
I _{FLT}	Current flowing through the Zener diode.
I _{FLT MAX}	Maximum RMS fault current the Zener diode component of the device can withstand and remain resettable; testing is conducted at rated voltage with no load connected to V _{OUT} .
V _{INT MAX}	The voltage (V _{IN} - V _{OUT} "post trip") at which typical qualification devices (98% devices, 95% confidence) survived at least 100 trip cycles and 24 hours trip endurance when "tripped" at the specified voltage and current (I _{PTC}).
I _{PTC}	Current flowing through the PPTC portion of the circuit.
I _{OUT}	Current flowing out the V _{OUT} pin of the device.
Trip Event	A condition where the PPTC transitions to a high resistance state, thereby limiting I _{PTC} , and significantly increasing the voltage drop between V _{IN} and V _{OUT} .

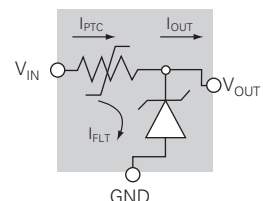
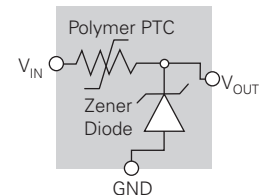

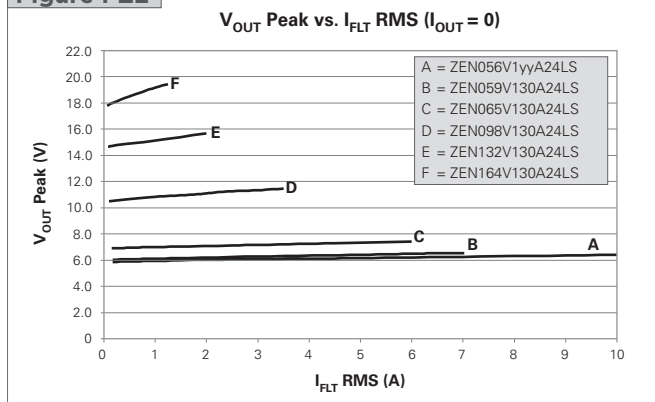
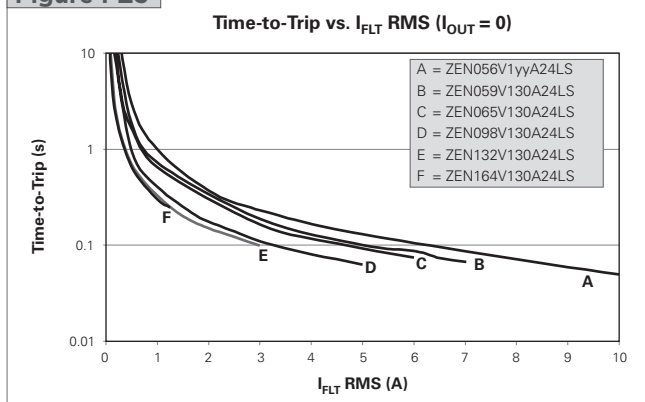
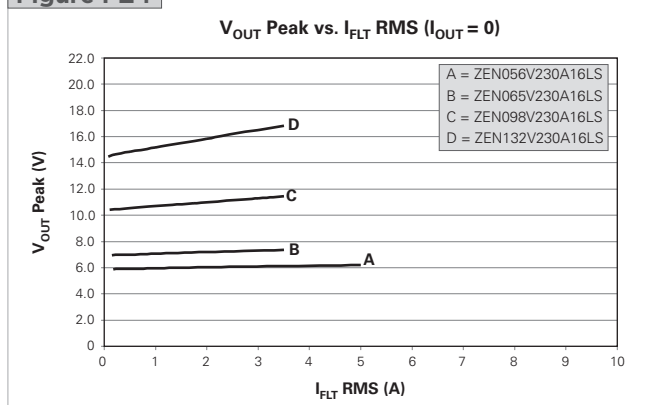
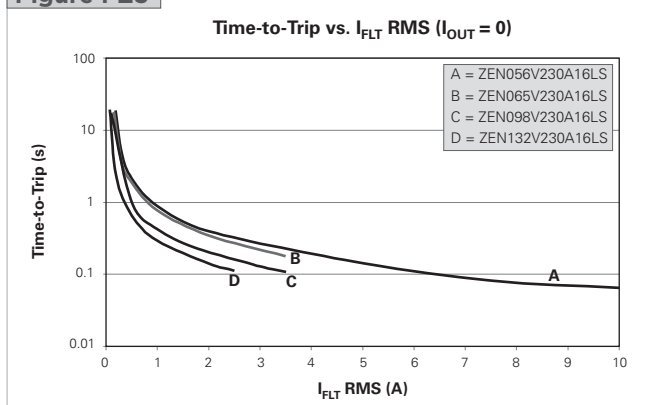
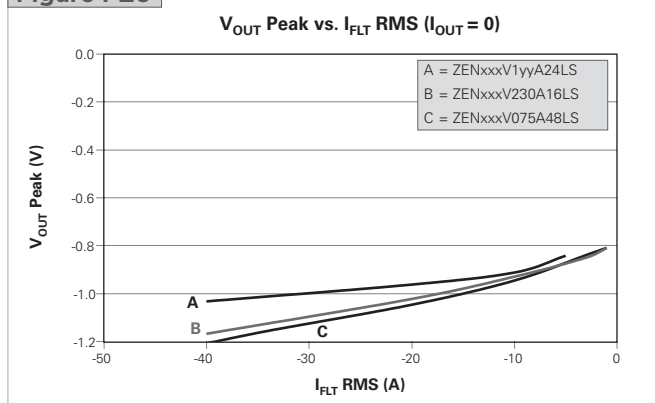
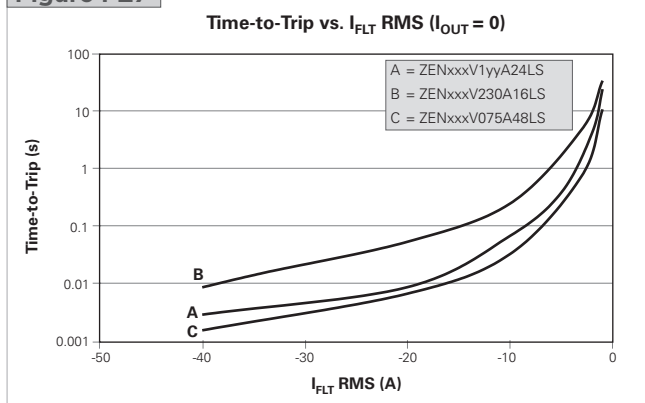
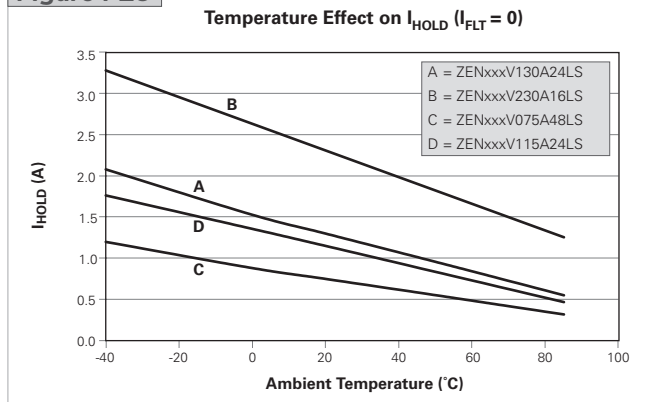
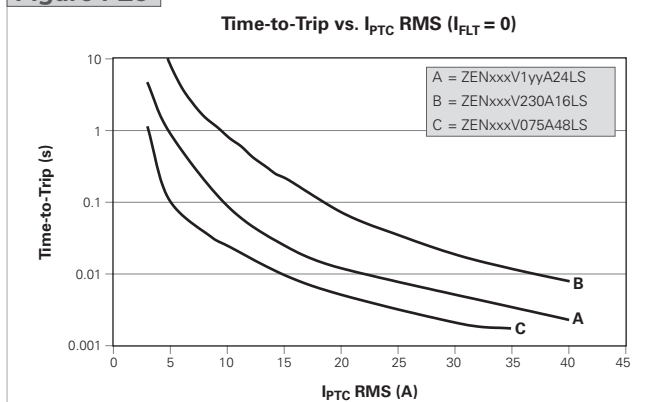
Figures PZ2-PZ9 Typical Performance Curves for PolyZen Devices - LS Series
Figure PZ2

Figure PZ3

Figure PZ4

Figure PZ5

Figure PZ6

Figure PZ7

Figure PZ8

Figure PZ9

Figures PZ10-PZ17 Typical Performance Curves for PolyZen Devices - CE Series

Figure PZ10

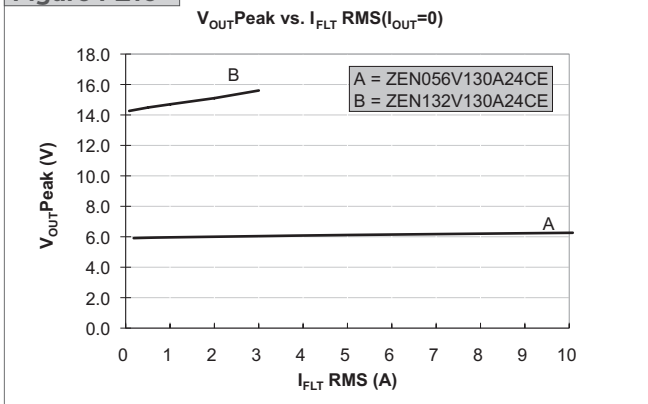

Figure PZ11

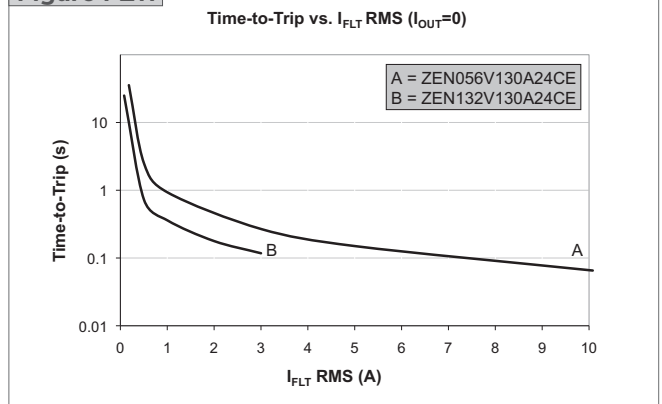

Figure PZ12

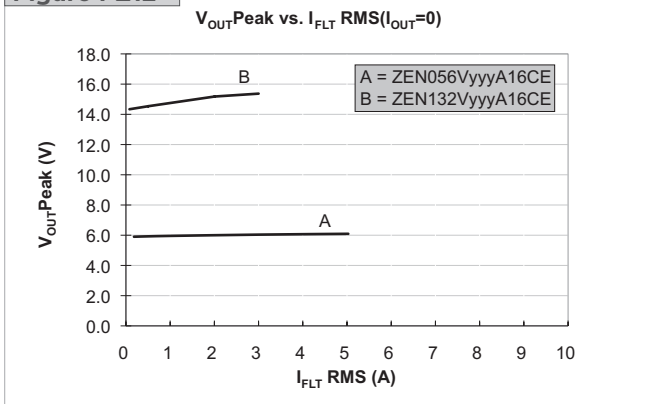

Figure PZ13

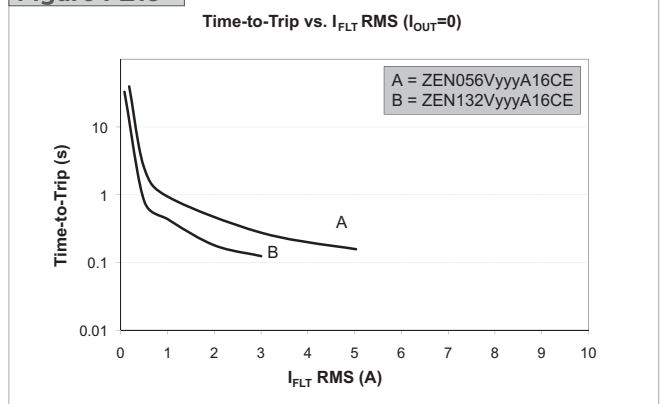

Figure PZ14

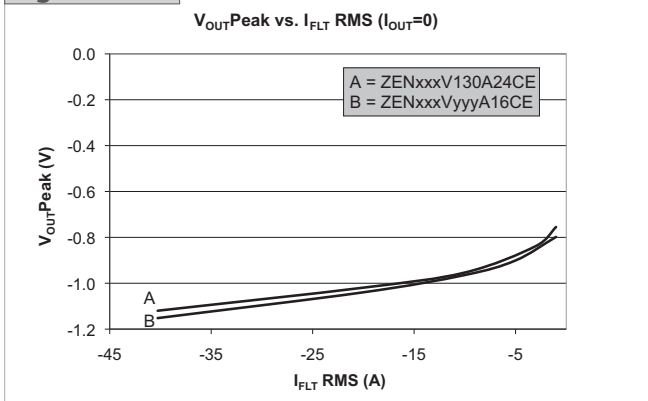

Figure PZ15

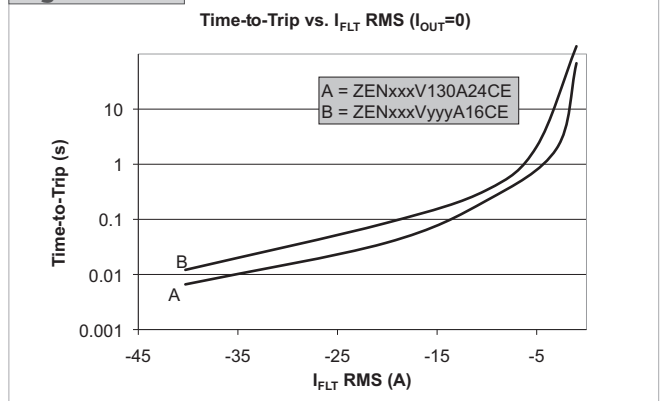

Figure PZ16

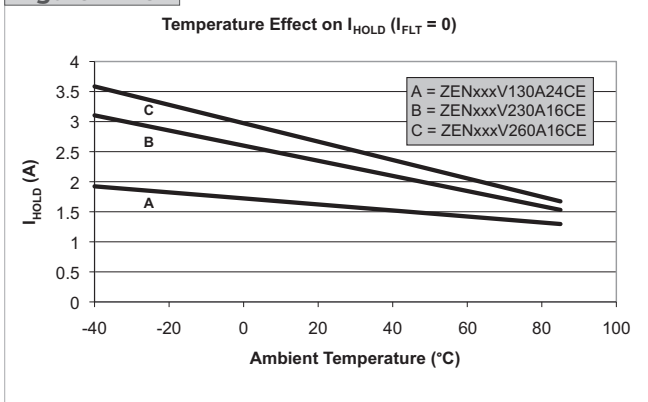
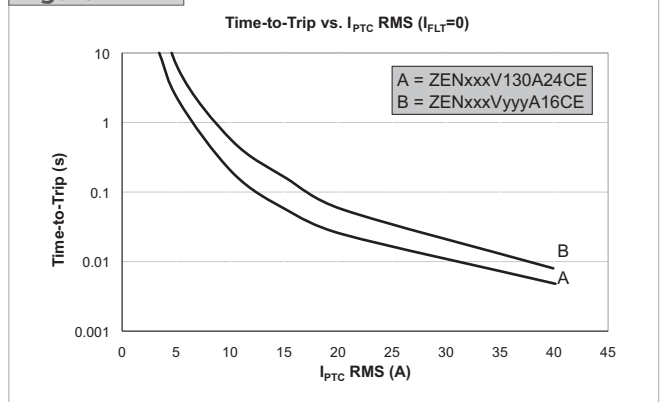

Figure PZ17



5

Table PZ3 General Characteristics for PolyZen Devices

Operating temperature range	-40° to +85°C	
Storage temperature	-40° to +85°C	
ESD withstand	15kV	Human body model
Diode capacitance	4200pF	Typical @ 1MHz, 1V RMS
Construction	RoHS compliant	

Figures PZ18-PZ22 Basic Operation Examples for PolyZen Devices - LS Series
Figure PZ18

Figure PZ19

Figure PZ20

Figure PZ21

Figure PZ22

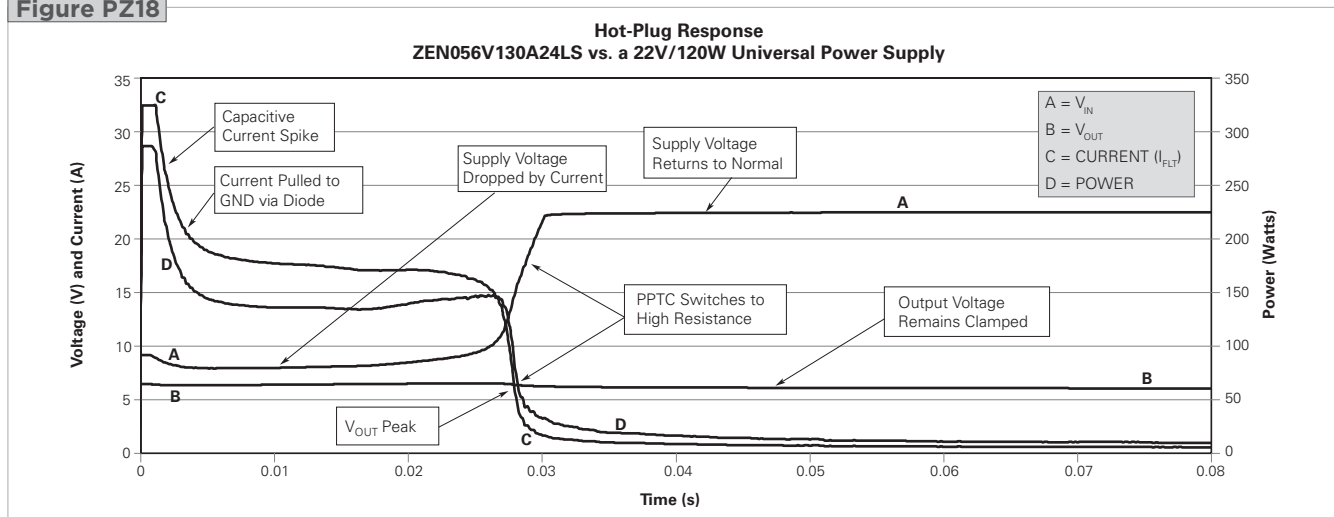
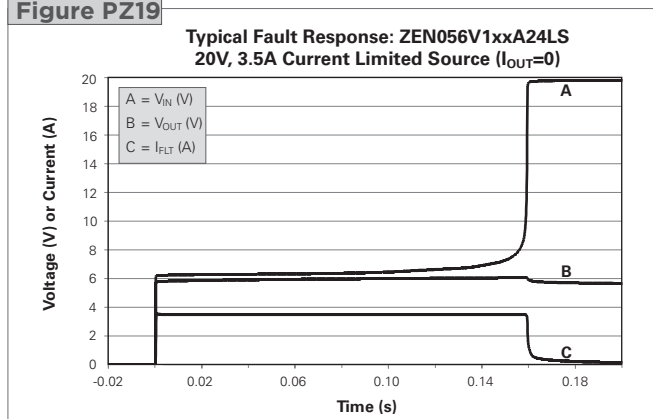
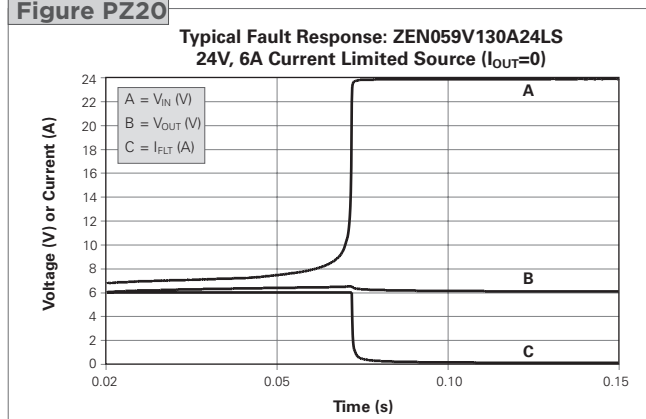
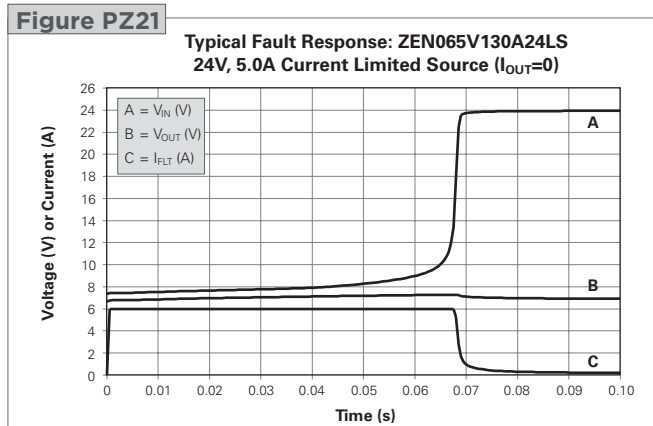
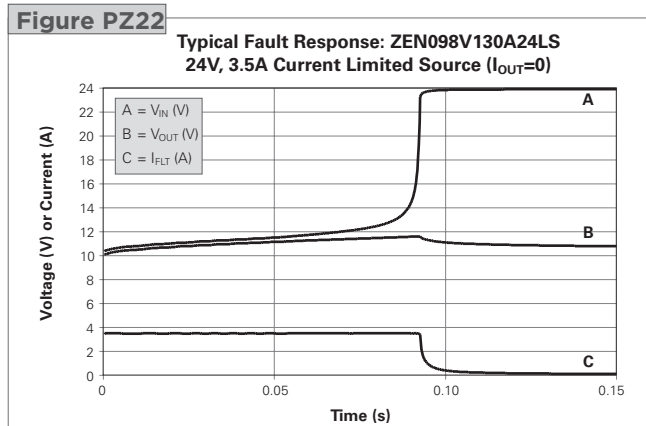
Figure PZ23

Typical Fault Response: ZEN132V130A24LS
24V, 2.0A Current Limited Source ($I_{OUT}=0$)

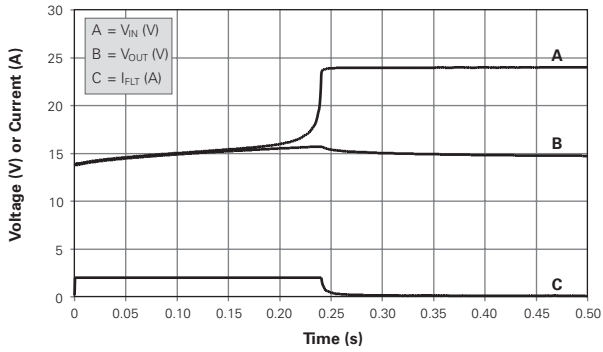

Figure PZ24

Typical Fault Response: ZEN164V130A24LS
24V, 1.0A Current Limited Source ($I_{OUT}=0$)

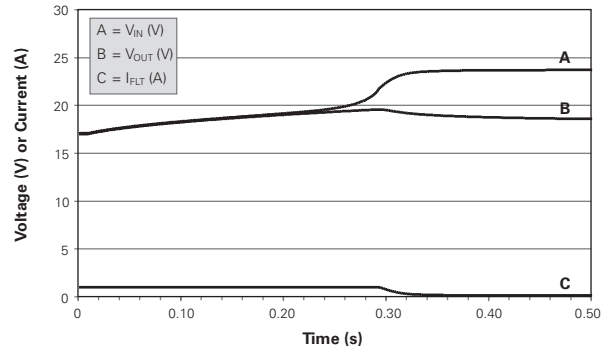

Figure PZ25

Typical Fault Response: ZEN056V230A16LS
16V, 5.0A Current Limited Source ($I_{OUT}=0$)

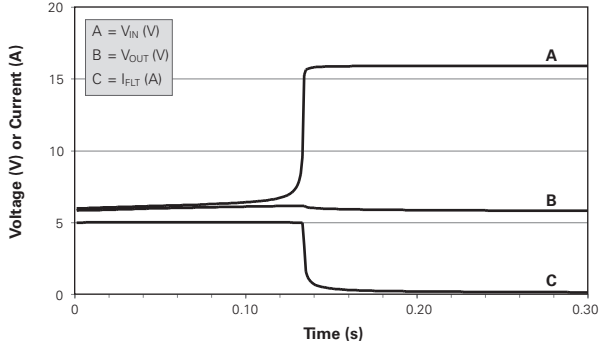

Figure PZ26

Typical Fault Response: ZEN065V230A16LS
16V, 3.5A Current Limited Source ($I_{OUT}=0$)

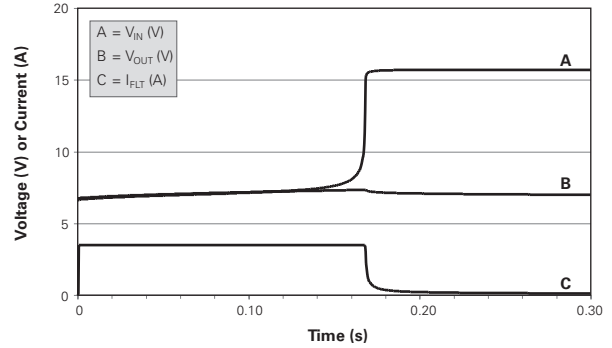

Figure PZ27

Typical Fault Response: ZEN098V230A16LS
16V, 3.5A Current Limited Source ($I_{OUT}=0$)

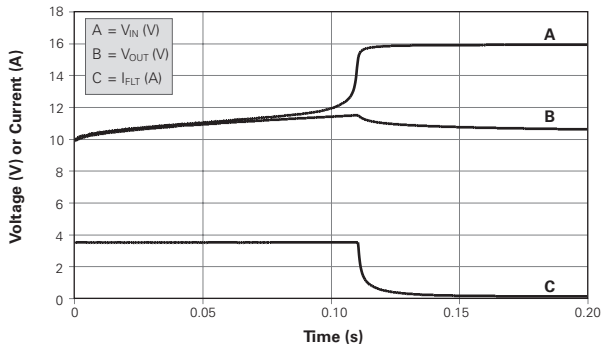

Figure PZ28

Typical Fault Response: ZEN132V230A16LS
20V, 2.0A Current Limited Source ($I_{OUT}=0$)

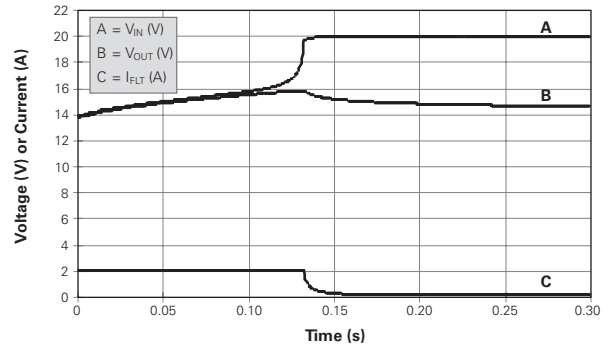

Figure PZ29

Typical Fault Response: ZEN056V075A48LS
48V, 10.0A Current Limited Source ($I_{OUT}=0$)

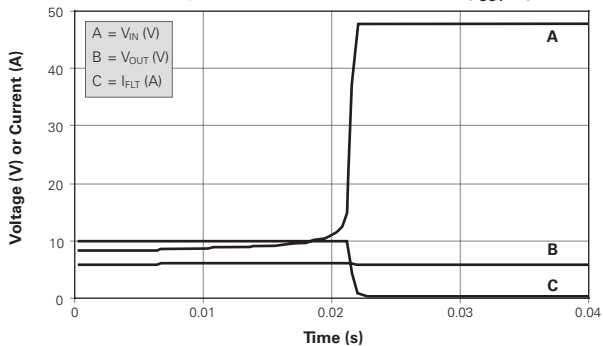
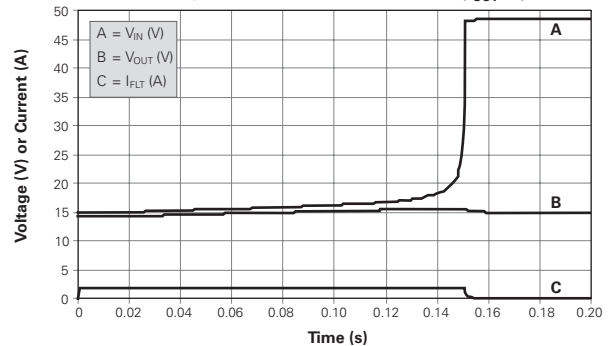

Figure PZ30

Typical Fault Response: ZEN132V075A48LS
48V, 2.0A Current Limited Source ($I_{OUT}=0$)



5

Figures PZ31-PZ35 Basic Operation Examples for PolyZen Devices - CE Series
Figure PZ31

Figure PZ32

Figure PZ33

Figure PZ34

Figure PZ35

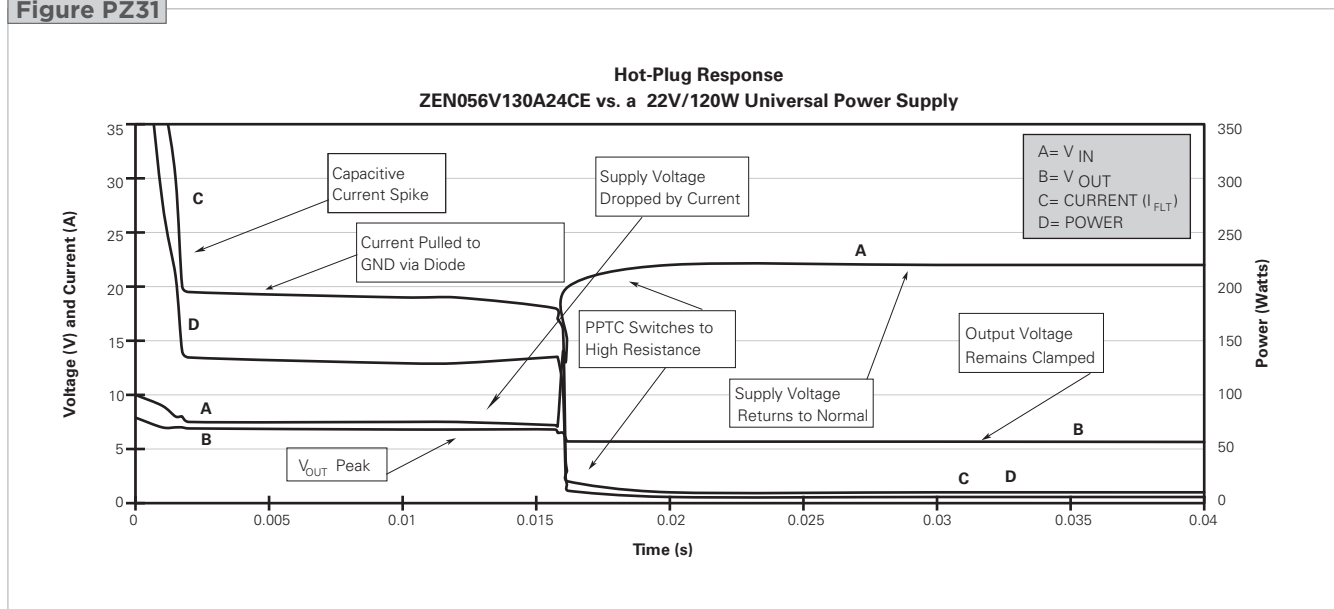
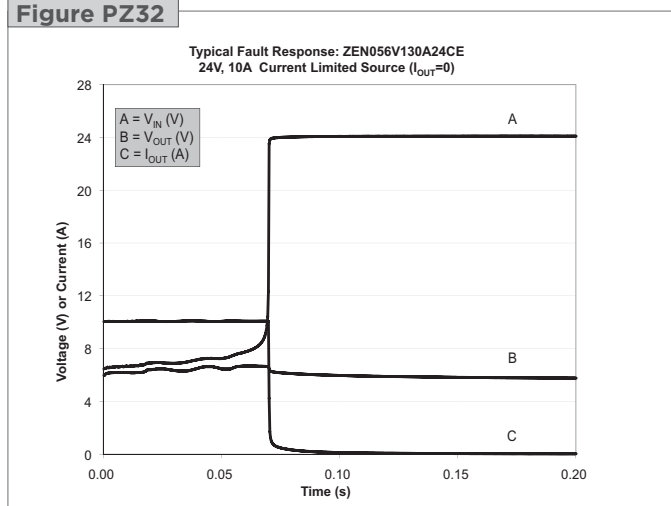
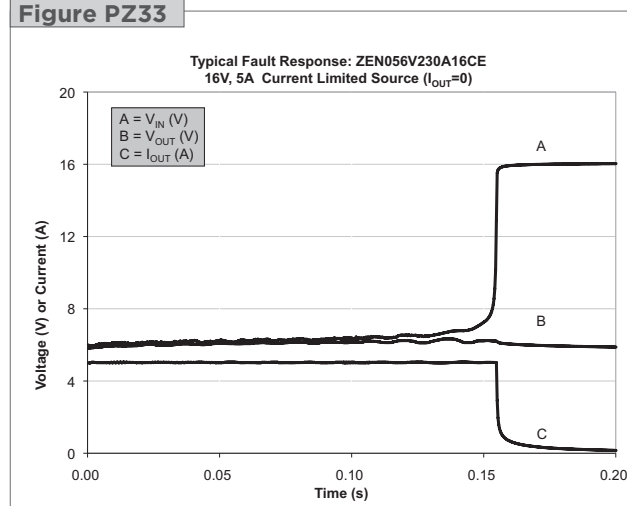
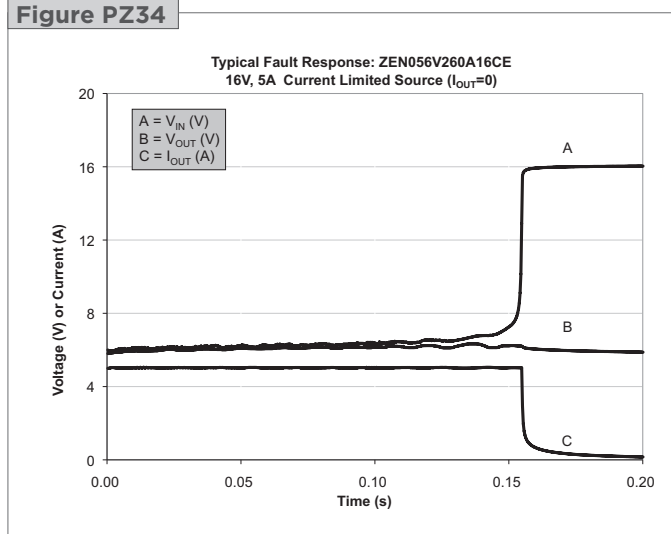
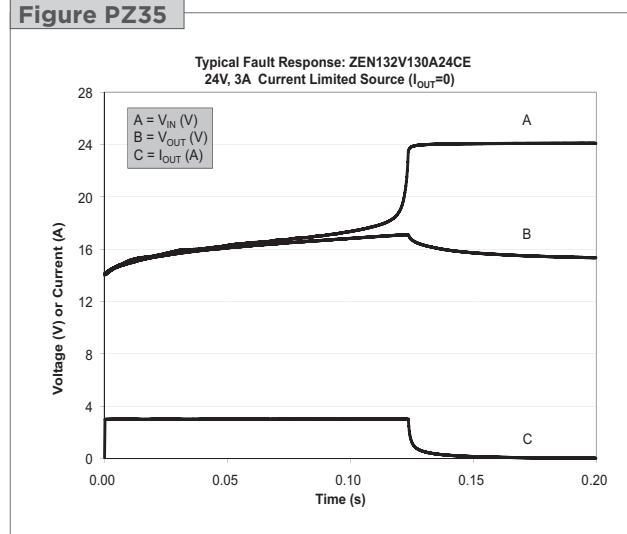
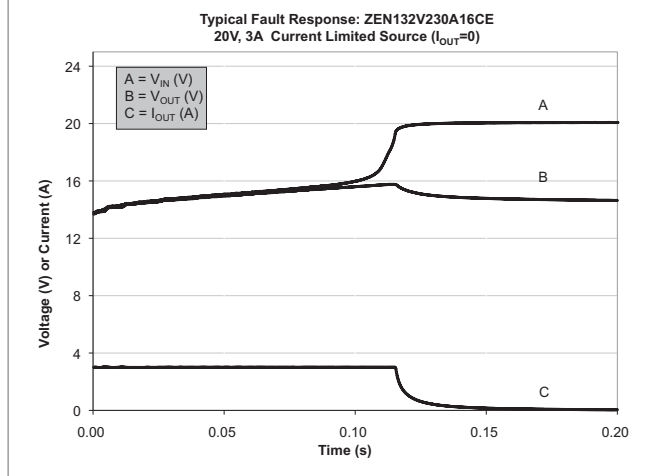
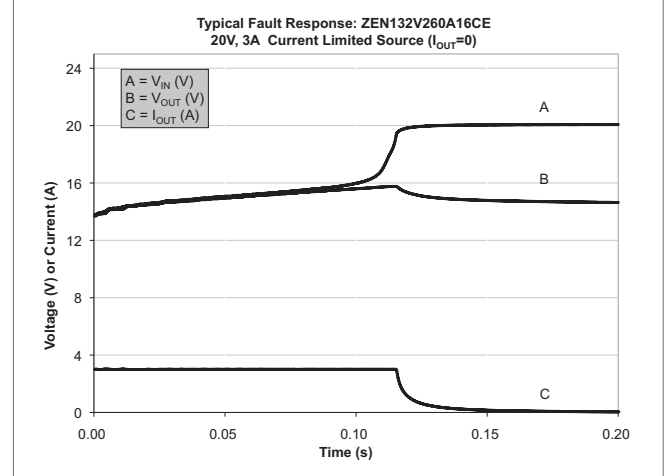
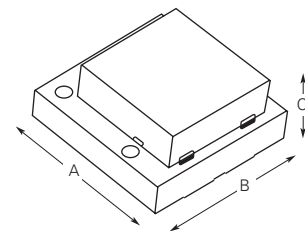
Figure PZ36

Figure PZ37

Table PZ4 Packaging and Marking Information for PolyZen Devices

Part Number	Bag Quantity	Tape & Reel Quantity	Standard Package
ZENxxxVyyyAzzLS	-	3,000	15,000
ZENxxxVyyyAzzCE	-	4,000	20,000

Table PZ5 Dimensions for PolyZen Devices in Millimeters and (Inches)
ZENxxxVyyyAzzLS Devices

	A		B		C	
	Min	Max	Min	Max	Min	Max
mm	3.85	4.15	3.85	4.15	1.40	2.00
in	(0.152)	(0.163)	(0.152)	(0.163)	(0.055)	(0.081)

ZENxxxVyyyAzzCE Devices

	A		B		C	
	Min	Max	Min	Max	Min	Max
mm	4.80	5.20	3.80	4.20	0.80	1.20
in	(0.189)	(0.205)	(0.150)	(0.165)	(0.031)	(0.047)

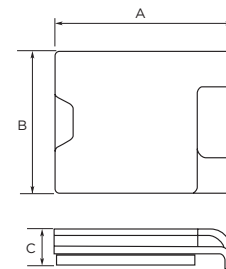
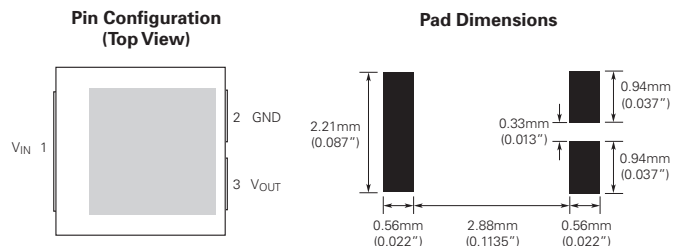
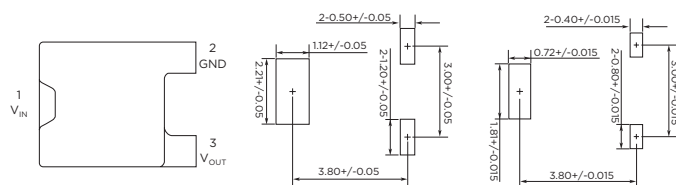

Table PZ6 Pad Layout and Configuration Information for PolyZen Devices
ZENxxxVyyyAzzLS Devices

Pin Number	Pin Name	Pin Function
1	V _{IN}	V _{IN} = Protected input to Zener diode
2	GND	GND = Ground
3	V _{OUT}	V _{OUT} = Zener regulated voltage output



ZENxxxVyyyAzzCE Devices

Pin Number	Pin Name	Pin Function
1	V _{IN}	V _{IN} = Protected input to Zener diode
2	GND	GND = Ground
3	V _{OUT}	V _{OUT} = Zener regulated voltage output

Solder Reflow and Rework Recommendation for PolyZen Devices
Classification Reflow Profiles

Profile Feature	Pb-Free Assembly
Average Ramp Up Rate (T_SMAX to T_p)	3°C/ s Max
Preheat	
• Temperature Min (T _S MIN)	150°C
• Temperature Max (T _S MAX)	200°C
• Time (ts Preheat)	60-180 s
Time Maintained Above:	
• Temperature (T _L)	217°C
• Time (t _L)	60-150 s
Peak/Classification Temperature (T_p)	260°C
Time within 5°C of Actual Peak Temperature	
Time (tp)	20-40 s
Average Ramp Down Rate (T_p to T_L)	6°C/ s Max
Time 25°C to Peak Temperature	8 Minutes Max

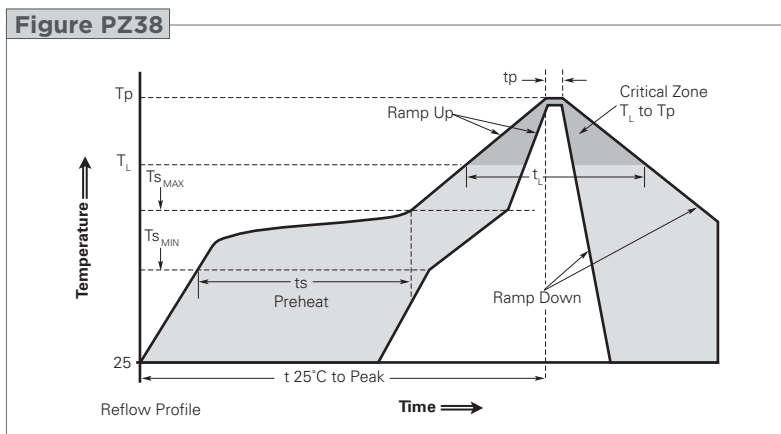
Note: All temperatures refer to the top side of the package, measured on the package body surface.



Tape and Reel Specifications for PolyZen Devices in Millimeters

Figure PZ39 EIA Referenced Taped Component Dimensions for PolyZen Devices in Millimeters (mm)

Description	ZENxxxVyyyAzzLS Devices	ZENxxxVyyyAzzCE Devices
A ₀	4.35	4.35
B ₀	4.35	5.35
K ₀	2.30	1.35

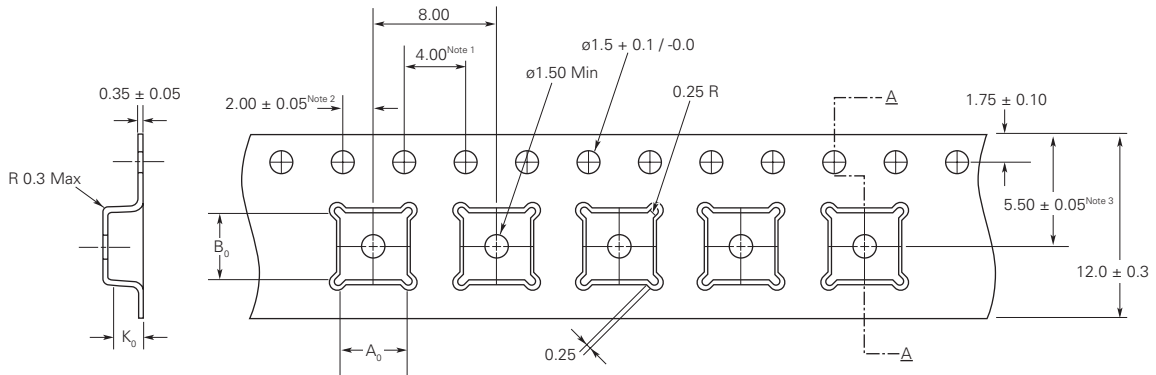

Notes:

1. 10 sprocket hole pitch cumulative tolerance ± 0.2
2. Camber in compliance with EIA 481
3. Pocket position relative to sprocket hole measured as true position of pocket, not pocket hole

Figure PZ40 Reel Dimensions for PolyZen Devices in Millimeters (mm)

Description	Dimension (mm)
A _{Max}	330
N _{Min}	102
W ₁	8.4
W ₂	11.1

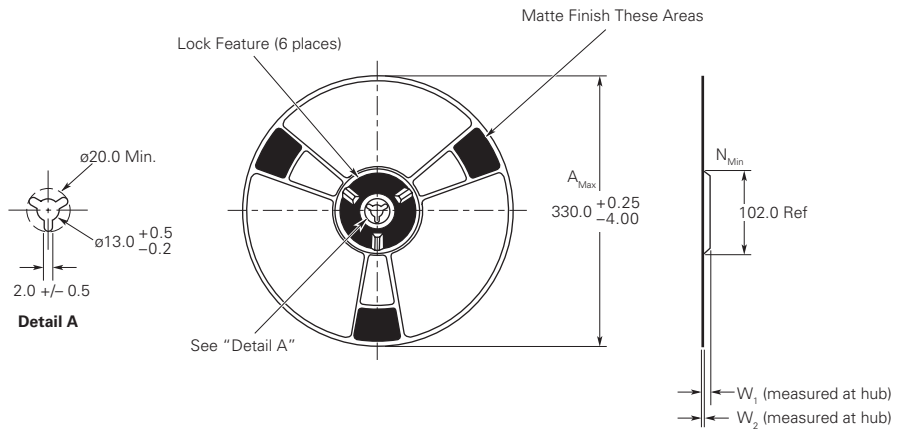

Part Numbering System for PolyZen Devices

ZEN 056V 130A 24 LS & CE

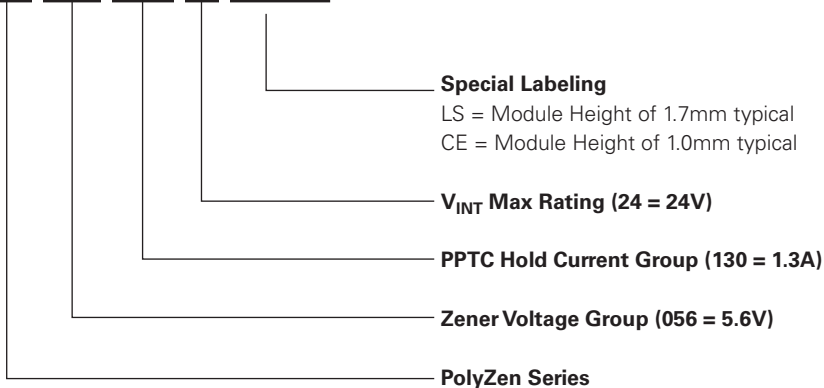

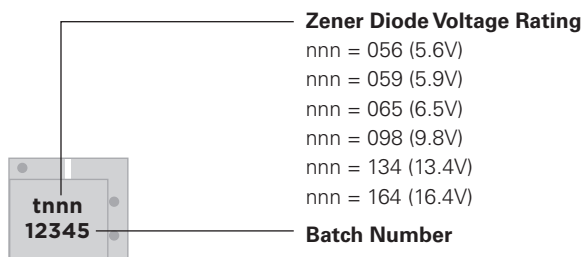
Part Marking System for PolyZen Devices
ZENxxxVyyyAzzLS Devices

ZENxxxVyyyAzzCE Devices

Markings	V_z	Hold Current	Batch Number
05613	5.6V	1.3A	
#####			Last 4 digits of batch number

Notice :

Information furnished is believed to be accurate and reliable. However, users should independently evaluate the suitability of and test each product selected for their own applications. Tyco Electronics Corporation and its affiliates in the TE Connectivity Ltd. group of companies ("TE") reserve the right to change or update, without notice, any information contained in this publication; to change, without notice, the design, construction, processing, or specification of any product; and to discontinue or limit production or distribution of any product. This publication supersedes and replaces all information previously supplied. Without express written consent by an officer of TE, TE does not authorize the use of any of its products as components in nuclear facility applications, aerospace, or in critical life support devices or systems. TE expressly disclaims all implied warranties regarding the information contained herein, including, but not limited to, any implied warranties of merchantability or fitness for a particular purpose. TE's only obligations are those in the TE Standard Terms and Conditions of Sale and in no case will TE be liable for any incidental, indirect, or consequential damages arising from the sale, resale, use, or misuse of its products.